



PRS DFB-M50 / PRS SFB-M50

Features & Sleeves



Key Features

- Crash Rated Bollard Product
- Features & Sleeves
- HVM Crash Rated BOLLARD British Standard Engineered and Made
- in UAE, Following UK PAS68, PAS69 Standards.
- Perimeter security solution to protect what matters most.
- First crash rated Bollard made in UAE "Manufacturedlocally by



SLANT



FLAT



DOME

Introduction

HVM Crash Rated BOLLARD British Standard Engineered and Made in UAE, Following UK PAS68, PAS69 Standards. Perimeter security solution to protect what matters most. First crash rated Bollard made in UAE "Manufacturedlocally by PROSECURE" Bollard has been successfully Engineered to the British PAS 68 specification stopping 7.5t@ 50mph (80kph).

Features & Sleeves

- Security Rating V/7500(N3)/80/90
- Foundation type-C
- Embedment: 580mm/125mm
- Height above ground: 1000mm
- Diameter: 273mm
- Finish: Polyester Powder Coated
- Options: Range of Aesthetic Sleeves, including stainless steel removable

PROSECURE-FZCO # 2024 V: 001

Redesigned technical summary in Hikvision-style table layout. All original pages are appended after this branded section to preserve the exact original model numbers, specifications, diagrams, and descriptions.

Technical Specifications

Category	Parameter	Value
Crash Rated Bollard Product	PRS	DFB-M50 / PRS SFB-M50 Fixed
Features & Sleeves	HVM	Crash Rated BOLLARD British Standard Engineered and Made
		in UAE, Following UK PAS68, PAS69 Standards. Perimeter security solution to protect what matters most.
	First	crash rated Bollard made in UAE "Manufacturedlocally by
	PROSECURE" Bollard has been successfully Engineered to the British PAS 68 specification stopping 7.5t@ 50mph (80kph).	
Foundation type-C	Security	Rating V/7500(N3)/80/90
	Embedment: 580mm/125mm	Height above ground: 1000mm
	Diameter: 273mm	Finish: Polyester Powder Coated Options: Range of Aesthetic Sleeves, including stainless steel
SLANT	Bollard	PRS DFB-M50 /PRS SFB-M50 Fixed
Structure Dimension	Revision	V: 001 Revision Date: 10/01/2024
	Paper	Size A4 Release Date: 10/01/2024
Crash Rated Bollard Product	PRS	DFB-M30 /PRS SFB-M30 Fixed
Features & Sleeves	Security	Rating V/7,500(N2)/48/90
	Bollard	Diameter 219 mm
Foundation Type-C	Embedment: 580mm/50mm	Finish: Polyester Powder Coated
	Height	AboveGround 1000mm Options: Range of Aesthetic Sleeves, including stainless steel
SLANT	Bollard	PRS DFB-M50 /PRS SFB-M30 Fixed

Category	Parameter	Value
Structure Dimension	■■■■■mm	■■■■■mm
	■■■■■MAX.	Bollard PRS DFB-M50 /PRS SFB-M30 Fixed
	M■■■	M■■■
	M■■■	M■■■

Crash Rated Bollard Product

PRS DFB-M50 / PRS SFB-M50 Fixed

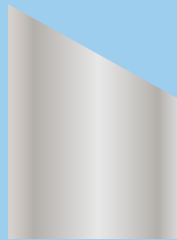

SLANT



FLAT



DOME

■ Introduction

HVM Crash Rated BOLLARD British Standard Engineered and Made in UAE, Following UK PAS68, PAS69 Standards.

Perimeter security solution to protect what matters most. First crash rated Bollard made in UAE "Manufactured locally by PROSECURE" Bollard has been successfully Engineered to the British PAS 68 specification stopping 7.5t@ 50mph (80kph).

■ Features & Sleeves

- Security Rating V/7500[N3]/80/90
- Foundation type-C
- Embedment: 580mm/125mm
- Height above ground: 1000mm
- Diameter: 273mm
- Finish: Polyester Powder Coated
- Options: Range of Aesthetic Sleeves, including stainless steel removable

Crash Rated Bollard Product

PRS DFB-M30 /PRS SFB-M30 Fixed



SLANT



FLAT



DOME

■ Introduction

HVM Crash Rated BOLLARD British Standard Engineered and Made in UAE, Following UK PAS68, PAS69 Standards.

Perimeter security solution to protect what matters most.

First crash rated Bollard made in UAE "Manufactured locally by PROSECURE" Bollard has been successfully Engineered to the British PAS 68 specification stopping 7.5t@ 50mph (80kph).

■ Features & Sleeves

- Security Rating V/7,500[N2]/48/90
- Bollard Diameter 219 mm
- Foundation Type-C
- Embedment: 580mm/50mm
- Finish: Polyester Powder Coated
- Height AboveGround 1000mm
- Options: Range of Aesthetic Sleeves, including stainless steel removable

Structure Dimension

Bollard | PRS DFB-M50 / PRS SFB-M30 Fixed

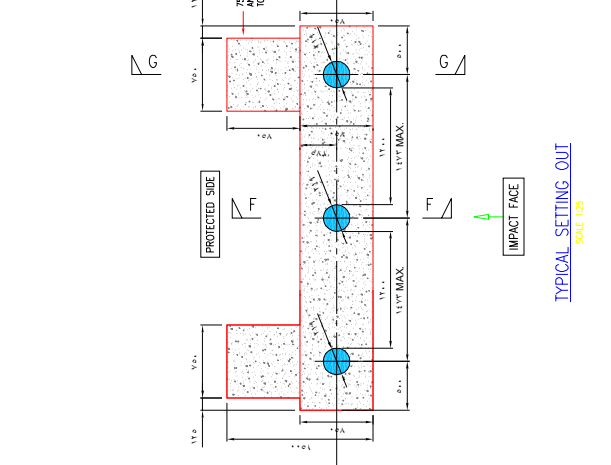
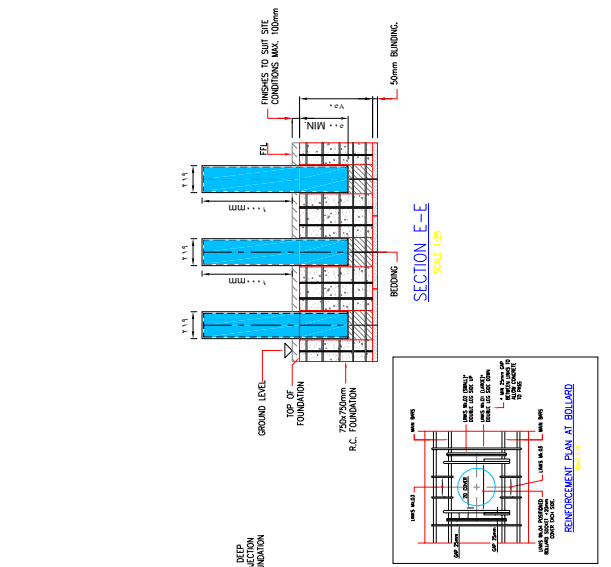
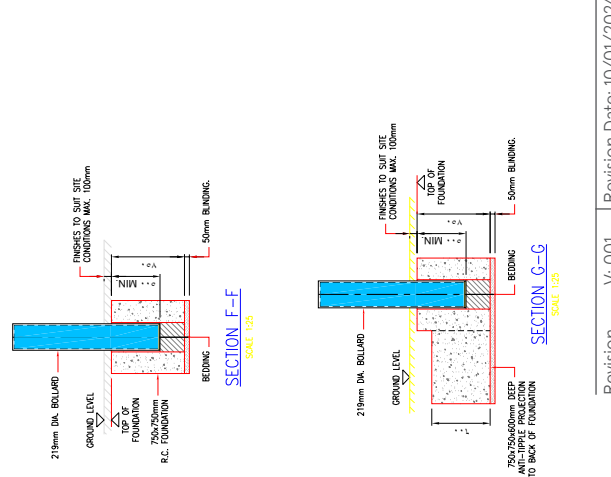
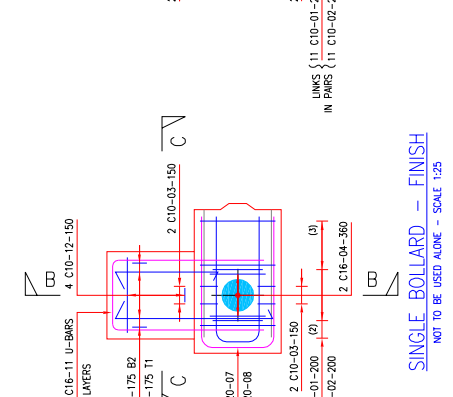
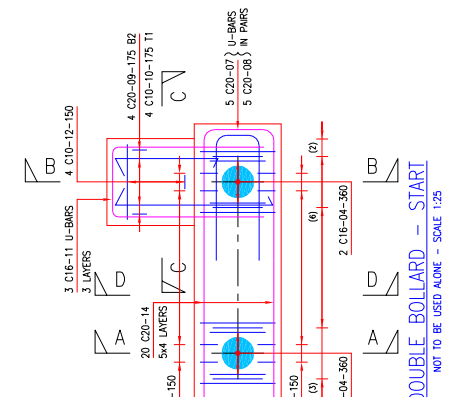
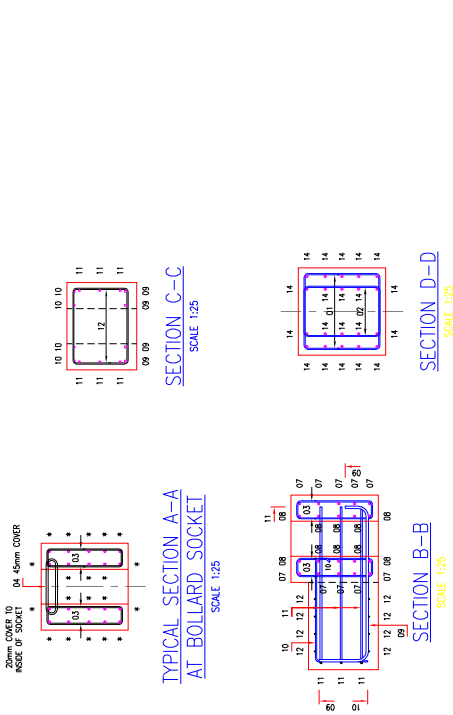

Revision	V: 001	Revision Date:	10/01/2024
Paper Size	A4	Release Date:	10/01/2024



